

# Spike 26in Alloy Front Suspension Mens Bike

Assembly Manual

332/4707



**Important – Please read these instructions fully before starting assembly**

These instructions contain important information that will help you get the best from your bike, ensuring safe and correct assembly, use and maintenance.

If you need help or have damaged or missing parts, call the **Customer Helpline on 0845 640 0800**

|   |    |
|---|----|
| Safety Information.....                   | 3  |
| In the Box .....                          | 5  |
| Parts .....                               | 5  |
| Tools .....                               | 5  |
| Assembly .....                            | 6  |
| Step 1 .....                              | 6  |
| Step 2 .....                              | 7  |
| Step 3 .....                              | 8  |
| Step 4 .....                              | 9  |
| Step 5 .....                              | 10 |
| Step 6 .....                              | 12 |
| Step 7 .....                              | 13 |
| Riding Advice .....                       | 14 |
| Before Riding .....                       | 14 |
| Riding in Bad Weather .....               | 16 |
| Riding in the Dark .....                  | 16 |
| Riding Using Personal Music Players ..... | 16 |
| Using Child Seats .....                   | 16 |



# Safety Information

Customer Helpline 0845 640 0800

**Important – Please read these instructions fully before installation**



**WARNING!** This Bike has been designed, assembled and tested in accordance with the BS EN 14766:2005 standard to ensure your safety. To make sure the bike remains safe, it should only be used for recreational use. Under no circumstances should it be used for competitive cycling, stunting, jumping or acrobatic manoeuvres. This may result in serious personal injury and damage to the bike.

**WARNING!** This bike is only suitable for use by riders (including any panniers and/or luggage) with a weight of less than 100 kg (220 lb).

**WARNING!** Under no circumstances should the bike be ridden with loose or torn clothing.

**WARNING!** Always take extra care when riding in wet, foggy, windy or icy conditions. The brakes may not be as effective and the braking distances may be increased.

**WARNING!** When riding in the dark, always make sure that the bike is fitted with suitable reflectors and front and rear lights.

**WARNING!** When assembling the handlebars and stem to the bike frame, make sure the suspension forks are facing in the correct direction. If the suspension forks are assembled correctly, the brakes should be facing forwards. Failure to observe this warning may prevent the correct operation and may lead to personal injury and damage to the bike.

**WARNING!** When assembling the handlebars and stem, make sure it is inserted beyond the minimum insert mark. Failure to observe this warning may lead to a potentially unstable bike and may result in serious personal injury.

**WARNING!** When assembling the seat post, make sure it is inserted beyond the minimum insert mark. Failure to observe this warning may lead to a potentially unstable seat post and may result in serious personal injury.

**WARNING!** The front and rear tyres of the bike must be fully inflated before attempting to ride the bike. Under no circumstances should the tyres be inflated above the maximum pressure stated on the side of the tyres.

**WARNING!** Only inflate the front and rear tyres of the bike using a bicycle pump. Do not attempt to use another type of pump to inflate the tyres.



# Safety Information

Customer Helpline 0845 640 0800

**Important – Please read these instructions fully before assembly**



**CAUTION!** The safety and smooth running of the bike can only be preserved with regular maintenance. Always ensure the bike is maintained in accordance with the supplied maintenance manual.

**CAUTION!** Only use suitable tools to assemble the bike. The use of unsuitable tools may lead to personal injury and damage to the bike.

**CAUTION!** Always ensure all packaging is removed from the bike before assembly and use. Failure to remove the packaging may prevent the correct operation and may lead to personal injury and damage to the bike.

**CAUTION!** When assembling the bike frame, make sure all the cables are free to move and are not tangled. Failure to observe this caution may prevent correct operation and may lead to personal injury and damage to the bike.



**IMPORTANT!** Always take care when removing the packaging to prevent damage to the bike.

**IMPORTANT!** Before assembling the bike, check all the parts indicated in the manual are in the box. Inspect the parts for signs of damage. Do not assemble the bike if you observe any damaged components.



**NOTE!** The threads on the left and right pedals are different. To prevent damage to the threads, only tighten the pedals in the direction indicated on the stickers.

**NOTE!** Always recycle the packaging in accordance with local recycling schemes.

**NOTE!** The pedals and crank arms have colour coded stickers to indicate which pedal matches which Crank Arm.

**NOTE!** Locate the 'direction of rotation' arrow embossed on the side of the tyre. When the front wheel is assembled, the arrow should be pointing in the direction that the wheel will rotate.

## Parts

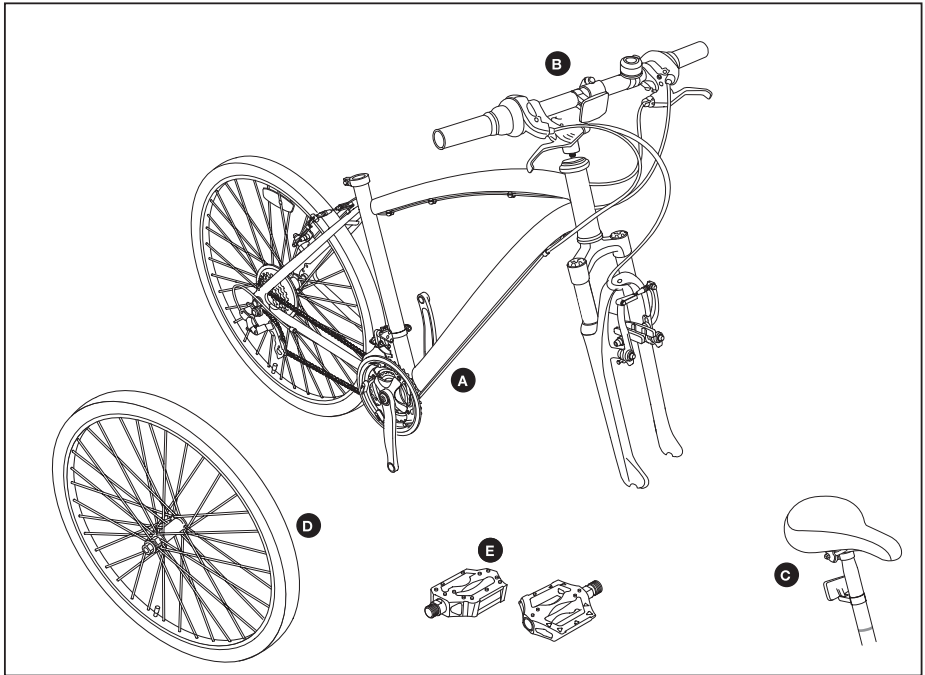

- A** Bike (supplied with rear wheel assembled)
- B** Handlebar and stem
- C** Seat post and saddle
- D** Front wheel
- E** Pedals (supplied in separate box)

## Tools

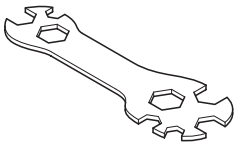

Multitool (supplied in separate box)

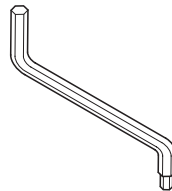

Hexagonal key (supplied in separate box)

## Step 1



**IMPORTANT!** Before assembling the bike, check all the parts indicated in the manual are in the box. Inspect the parts for signs of damage. Do not assemble the bike if you observe any damaged components.

**IMPORTANT!** Always take care when removing the packaging to prevent damage to the bike.

1. Remove the bike from the box and carefully remove all packaging. The following types of packaging are used to protect the bike during transit:
  - Cardboard Wrapping - This is used to protect the painted surfaces of the bike frame.
  - Cable Ties - These are used to secure loose parts to the partially assembled bike.
  - Stem Caps - These are placed in unprotected ends of the bike frame.



**NOTE!** Always recycle the packaging in accordance with local recycling schemes.

## Step 2

2a

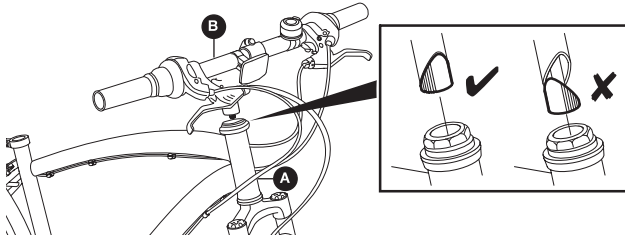

2b

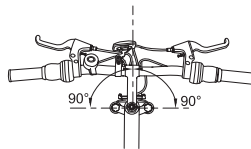
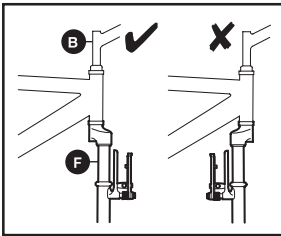

2c

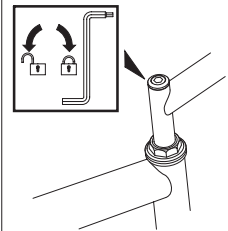

### 2a Insert the Stem



**WARNING!** When assembling the handlebars and stem, make sure it is inserted beyond the minimum insert mark. Failure to observe this warning may lead to a potentially unstable bike and may result in serious personal injury.

Ensuring the wedge nut is correctly aligned, insert the lower end of the handlebars and stem **B** into the steer tube of the bike **A**.

### 2b Align the Stem



**WARNING!** When assembling the handlebars and stem to the bike frame, make sure the suspension forks are facing in the correct direction. If the suspension forks are assembled correctly, the brakes should be facing forwards. Failure to observe this warning may prevent the correct operation of the bike and may lead to personal injury and damage to the bike.

Adjust the handlebars and stem **B** to the desired height and align with the suspension forks **F**. The suspension forks must be facing in the right direction as shown.

### 2c Securing the Stem

Using the supplied hexagonal key, tighten the stem bolt firmly.

## Step 3

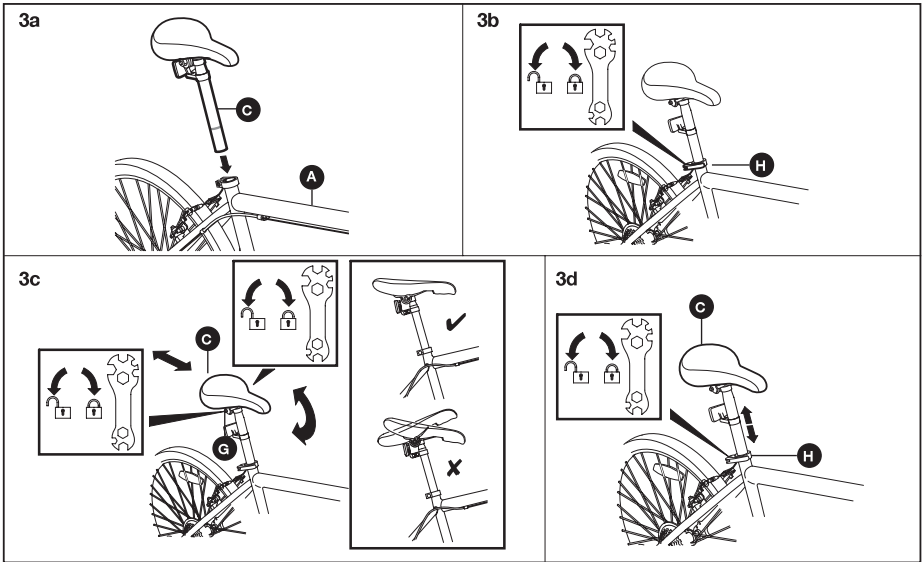

### 3a Insert the Seat Post and Saddle



**WARNING!** When assembling the seat post, make sure it is inserted beyond the minimum insert mark. Failure to observe this warning may lead to a potentially unstable seat post and may result in serious personal injury.

Insert the lower end of the seat post and saddle **C** into the seat tube of the bike **A**.

### 3b Securing the Seat Post

Using the supplied multi spanner, tighten the seat post bolt **H** firmly.

### 3c Adjusting the Position of the Saddle

The angle of the saddle **C** should be adjusted so that it is horizontal to the floor. To adjust the tilt of the saddle, loosen the saddle clamp nuts **G** a quarter of a turn at a time using the multitool supplied until the saddle can be moved.

If required, the saddle **C** can be moved forwards or backwards on the seat post while the saddle clamp nuts **G** are loose.

Once the saddle **C** is positioned correctly, retighten the saddle clamp nuts **G**.

### 3d Adjusting the Height of the Saddle

The height of the saddle **C** should be adjusted so that the Rider can comfortably touch the ground with both feet. To adjust the height of the saddle **C**, loosen the seat post bolt **H** until the seat post can move freely.

Once the saddle **C** is positioned correctly, retighten the seat post bolt **H**.



## Step 4

4a & 4b

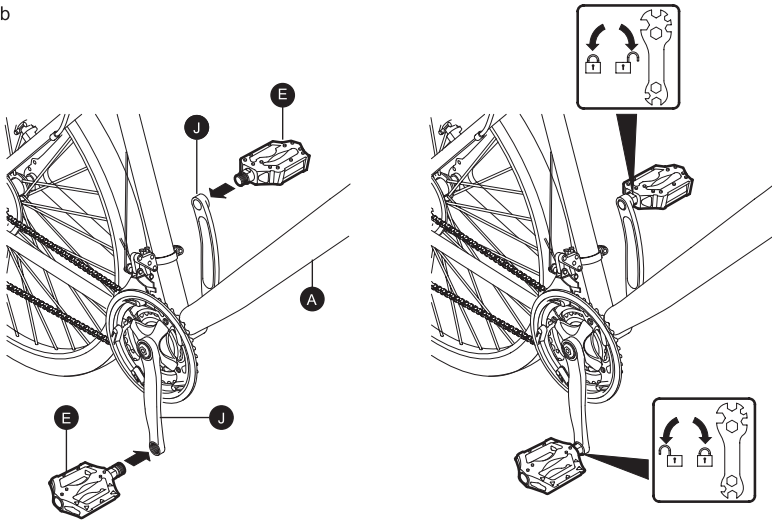

### NOTE

**NOTE!** The pedals **E** and crank arms **J** have colour coded stickers to indicate which pedal **E** matches which crank arm **J**.

**NOTE!** The threads on the left and right pedals are different. To prevent damage to the threads, only tighten the pedals in the direction indicated on the stickers.

#### 4a Fitting the Right Hand Pedal

Locate the right hand pedal **E**. This will have a blue sticker attached, note: turn clockwise to tighten.

Locate the right hand crank arm **J** on the bike **A**. This will also have a blue sticker attached.

Remove the sticker from the right hand pedal **E**.

Insert the threaded shaft of the right hand pedal **E** into the threaded hole of the right hand crank arm **J** and fully tighten in the direction indicated on the stickers using the multi tool supplied.

#### 4b Fitting the Left Hand Pedal

Locate the left hand pedal **E**. This will have a red sticker attached, note: turn anti-clockwise to tighten.

Locate the left hand crank arm **J** on the bike **A**. This will also have a red sticker attached.

Remove the sticker from the left hand pedal **E**.

Insert the threaded shaft of the left hand pedal **E** into the threaded hole of the right hand crank arm **J** and fully tighten in the direction indicated on the stickers using the multi tool supplied.

## Step 5

5a

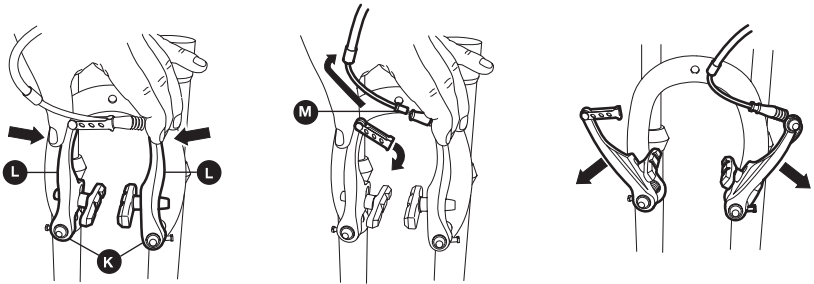

5b

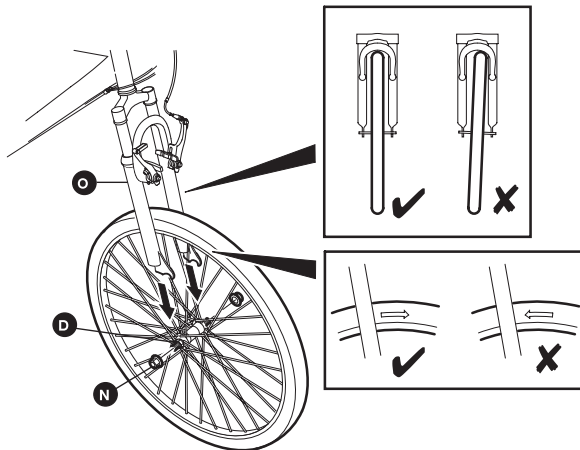

5c

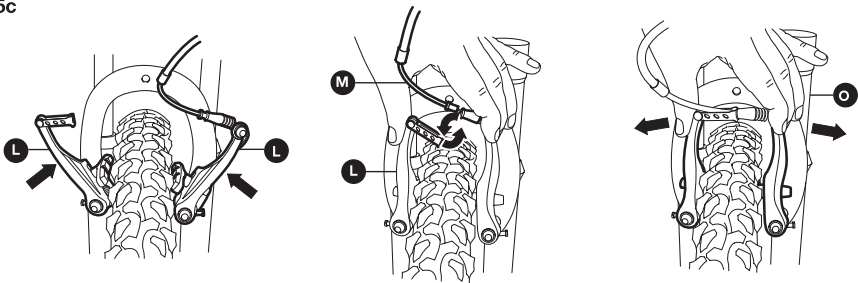

## Step 5 (continued)

### 5a Disconnect the Front Brake

Before the front wheel **D** can be installed, the front brake **K** must be disconnected. This allows the front tyre to pass between the brake pads during assembly.

Squeeze the two arms **L** of the front brake **K** together with one hand.

Using your other hand, pull the guide pipe and cable **M** across and up to release it from the right hand arm.

### 5b Insert the Wheel

Loosen the wheel nuts **N** on both ends of the front wheel **D** axle.



**NOTE!** Locate the 'Direction of Rotation' arrow embossed on the side of the tyre. When the front wheel **D** is assembled, the arrow should be pointing in the direction that the wheel will rotate.

Insert the axle of the front wheel **D** into the slots at the bottom of the suspension forks **O**.

While ensuring the wheel is centralised in the suspension forks **O**, fully tighten the wheel nuts **N** using the supplied multi tool.

### 5c Refit the Front Brake

Squeeze the two arms **L** of the front brake **K** together with one hand.

Using your other hand, locate the guide pipe and cable **M** into retaining plate slot of the right hand arm **L**.

Once the guide pipe and cable is fitted into slot/hole of retaining plate, release the pressure on the two arms **L**. Check that the front wheel **D** rotates freely. If it does not, the front wheel **D** may not be located centrally between the suspension forks **O**. Alternatively, the front brakes may need adjusting. Please refer to the supplied Maintenance Manual.

## Step 6

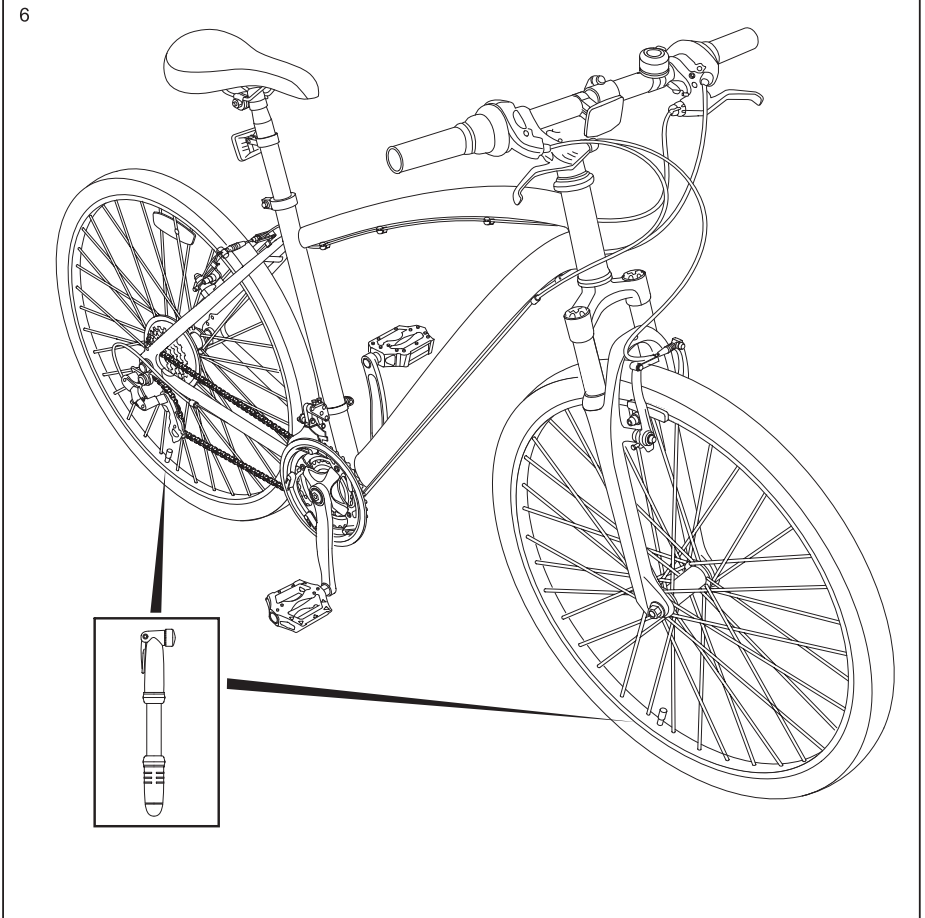

### 6 Inflate the Front and Rear Tyres



**WARNING!** The front and rear tyres of the bike must be fully inflated before attempting to ride the bike. Under no circumstances should the tyres be inflated above the maximum pressure stated on the side of the tyres.

**WARNING!** Only inflate the front and rear tyres of the bike using a bicycle pump. Do not attempt to use another type of pump to inflate the tyres.

Before riding the bike, the front and rear tyres must be fully inflated to the pressures indicated on the side of the tyre.

## Step 7

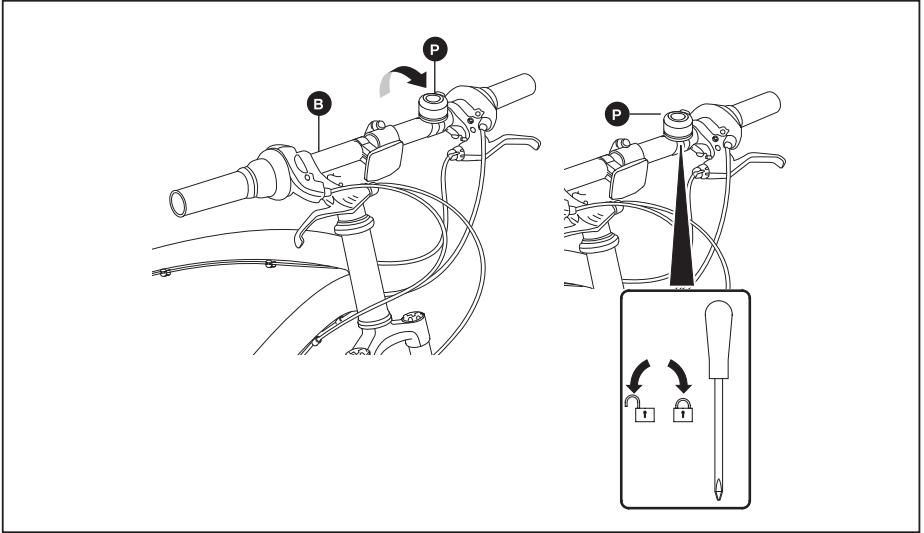

### 7 Position the Bell

Rotate the bell **P** so it is upright and position it along the length of the handlebars **B**. You must be able to operate the bell **P** without removing your hand from the handlebars.

Using a suitable screwdriver, tighten the retaining screw at the bottom of the bell **P**.

The Bike is now fully assembled and ready to ride.

## Before Riding

You should perform the following checks before riding your bike to ensure it is safe to use and operating correctly.

### **1. Is the Saddle Secure?**

While standing next to the bike, try and move the saddle from side to side. If the saddle moves you should retighten the seat post bolt or the saddle clamp bolts.

### **2. Are the Front and Rear Tyres Inflated Correctly?**

Squeeze the sides of the front and rear tyres. If they are soft they will need inflating. Re-inflate to the pressure indicated on the sides of the tyres using an approved bicycle pump.

### **3. Are the Pedals Tight?**

Using the supplied multitool, ensure both the left and right pedals are fully tight. Remember that the threaded shafts of the left and right pedals tighten in different directions.

### **4. Do the Brakes Work?**

Stand next to the bike and apply the front brake and push forwards. If the wheels move, the front brake may not be working correctly. If required, adjust the front brake as described in the Maintenance Manual.

Repeat the above check for the rear brake.

### **5. Do the Handlebars Move?**

Hold the front wheel between your legs to see if handlebar move left to right! If the handlebars move, the stem bolt may have become loose. Retighten the stem bolt.

### **6. Is the Bike Clean?**

The bike should be cleaned and re-oiled regularly to ensure it operates correctly.

## Before Riding

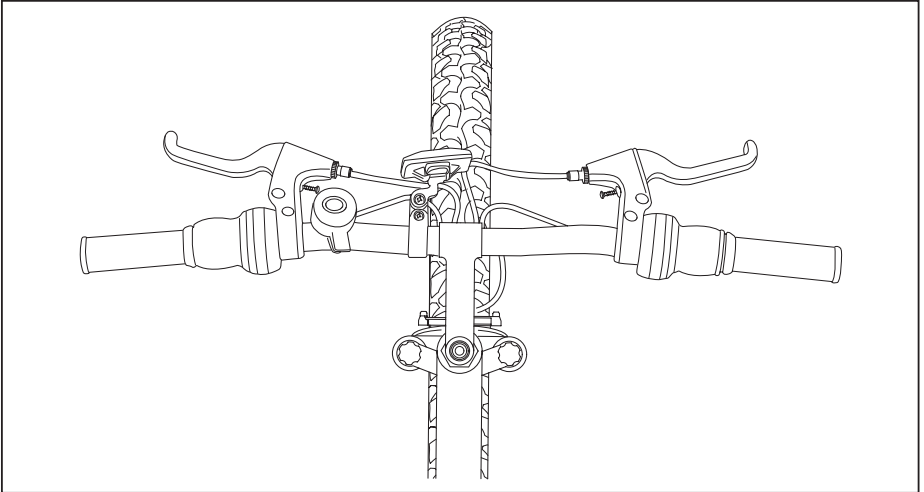

The bike is fitted with 21 gears to allow you to ride efficiently on all types of surfaces and gradients.

The gears are operated using two twist shifters mounted on the handlebars next to the brake levers. The left hand twist shifter operates the three front gears and the right hand twist shifter operates the six rear gears. The currently selected gear number is shown on the gear indicator for each twist shifter.

### **1. Operating the Front Gears**

To select a lower gear (larger), firmly turning the left hand twist shifter.

To select a higher gear (smaller), firmly turning the left hand twist shifter.

### **2. Operating the Rear Gears**

To select a lower gear (larger), firmly turning the right hand twist shifter.

To select a higher gear (smaller), firmly turning the right hand twist shifter.

### **3. Riding Up Hill**

When riding up hill, you should select a lower rear gear (for example number 1) and a lower front gear (for example number 1).

### **4. Riding Down Hill**

When riding down hill, you should select a higher rear gear (for example number 7) and a higher front gear (for example number 3).

## Riding in Bad Weather



**WARNING!** Always take extra care when riding in wet, foggy, windy or icy conditions. The brakes may not be as effective and the braking distances may be increased.

When riding in bad weather i.e. wet, foggy, windy or icy, always wear bright, reflective clothing which is warm and waterproof.

You should always give other road users clear signals in plenty of time particularly when approaching junctions. Always brake earlier than you would in the dry as the required braking distance will be increased.

Be aware that all types of surface become greasy or slippery in bad weather. Do not turn or brake suddenly.

## Riding in the Dark



**WARNING!** When riding in the dark, always make sure that the bike is fitted with suitable reflectors and front and rear lights.

It is essential that other road users can clearly see you when riding in the dark. Always wear bright, reflective clothing. Suitable reflectors should be fitted to the front and rear of the bike and if possible the wheels. A white light must be fitted to the front of the bike and a red light at the rear.

Before starting any journey in the dark or even twilight, ensure the lights are working correctly and are turned on.

Clean lights and reflectors regularly and make sure they can be seen from a distance.

## Riding Using Personal Music Players

It is recommended that personal music players are not used while riding a bike. These devices prevent you from hearing approaching vehicles and may prove to be a distraction and cause accident.

## Using Child Seats

If a child seat is fitted to the bike, make sure the child remains calm at all times. Take time to check that the child's arms, feet and clothing cannot be trapped in moving parts such as the wheels and gears.

The child seat must be installed in accordance with the manufacturer's information and should make sure any fitted accessories (like child seat) does not inhibit the functions of the bike (especially rear brakes) must verify all brakes and gears function properly.